

# Electric Power Pack Serie X32

XB / XB-Z

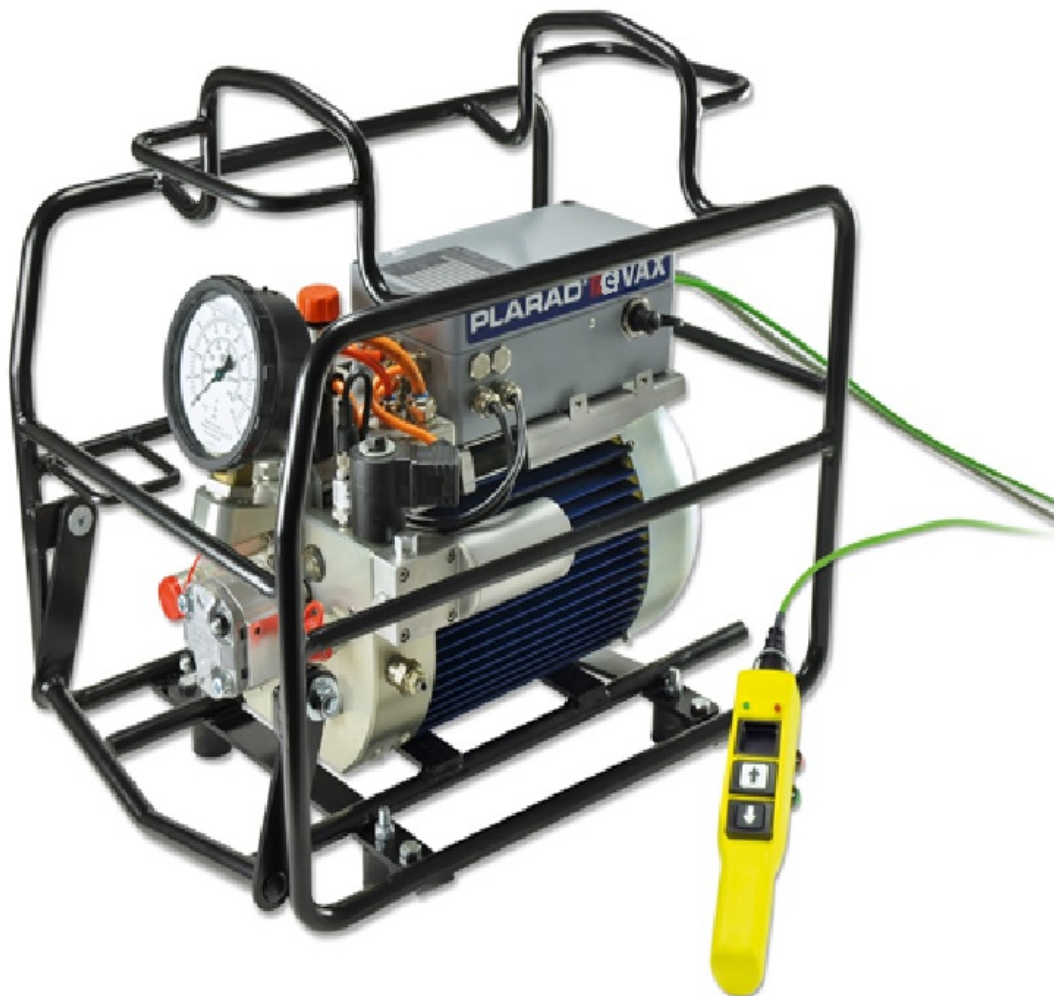

## Operating manual





# Contents

- 1. Manufacturer..... 3
- 2. Notes ..... 3
  - 2.1. CE mark..... 3
  - 2.2. Directives..... 3
  - 2.3. Information about this manual ..... 3
  - 2.4. Information about the workplace ..... 3
  - 2.5. Fundamental safety instructions on how to use mobile electrical devices..... 3
  - 2.6. Basic safety instructions for use of hydraulic power packs..... 4
  - 2.7. Product identification..... 5
- 3. Product information..... 6
  - 3.1. Intended use..... 6
  - 3.2. Non-intended or improper use ..... 6
  - 3.3. Other applicable operating instructions ..... 6
- 4. Scope of delivery ..... 6
- 5. Technical Data ..... 7
- 6. Transport..... 7
- 7. Preparing operation..... 7
  - 7.1. Safety instructions for operation ..... 7
  - 7.2. Check the oil level of the power pack and refill oil if necessary; connect the mains voltage ..... 8
- 8. Working with hydraulic tools..... 10
  - 8.1. Choosing tensioning or loosening mode ..... 10
  - 8.2. „Tightening“ mode ..... 10
    - 8.1.1. Setting the desired operating pressure ..... 10
    - 8.2.2. Performing the bolting operation ..... 10
  - 8.3. “Loosening” mode ..... 10
- 9. Error messages ..... 11
- 10. Remote control display ..... 11
- 11. Indicator lights on the remote control ..... 12
- 12. Maintenance instructions ..... 13
- 13. Instructions on disposal ..... 13



# 1. Manufacturer

Maschinenfabrik Wagner GmbH & Co.KG  
53804 Birrenbachshöhe, Much  
+49 (02245) 62-0

## 2. Notes

### 2.1. CE mark

The products are labelled with the CE mark. The Declaration of Conformity verifies that the products are in compliance with the safety directives of the European Union.

### 2.2. Directives

The product meets the requirements of the EC Machinery Directive 2006/42/EC.

### 2.3. Information about this manual

This manual contains important instructions on how to operate, set up and connect the power pack. Read these instructions carefully before putting the power pack into operation.

This is for your own protection and will provide you with important information on how to connect and use the power pack in a safe manner.

The operating manual is an integral part of the power pack. Store it close to the power pack where it is available at all times. Observing every detail of the operating manual is a requirement for using the power pack correctly and as intended. For this reason, pass this operating manual on to the next owner when selling the power pack.

Please note that details of the illustrations and technical specifications contained in this operating manual may deviate from the product you purchased.

The information provided in this operating manual is current as of the time it was printed. We reserve the right to make changes without prior notice.

### 2.4. Information about the workplace

We recommend that you use the hydraulic torque wrench in one-man operation. The operation of the power pack is restricted to trained and authorised personnel. Conduct a risk assessment before deciding to use the power pack in two-person operation. When using the power pack in two-person operation, ensure that the two users have previously cleared the application, the communication and the coordination of the power pack with one another. The person positioning the wrench should give the instructions regarding the operation of the power pack even if he is not operating the remote control.

The safety of the operator and the trouble-free operation of the power pack are only guaranteed

if you use original PLARAD components. This applies both to power pack components and spare parts.

If different components are used, Maschinenfabrik Wagner cannot guarantee the safe and reliable operation of the power pack.

## 2.5. Fundamental safety instructions on how to use mobile electrical devices

**ATTENTION!** When using electrical devices, you need to observe the following fundamental safety measures to ensure protection against electric shock and the risk of injury and fire hazards.

Read all of these instructions before using this power pack and store the safety instructions in a safe place for future reference.

### Safe working

1. Keep your work area neat and tidy
  - Disorganisation in the work area may result in accidents.
2. Take environmental influences into consideration
  - Do not expose the power pack to rain. Refrain from using the power pack in a wet or moist environment.
  - Provide for proper lighting in the work area.
  - Do not use the power pack in areas where there is a risk of fire or explosion.
3. Protect yourself against electric shock
  - Avoid bodily contact with grounded components.
4. Keep other persons at a distance
  - Do not allow other people, especially children, to touch the power pack or the cable. Keep them away from the work area.
5. Store unused power packs in a safe location
  - When not in use, the power packs should be stored in a dry, elevated or enclosed location and out of the reach of children.
6. Do not overload your power pack
  - You work better and more safely if staying within the specified range of capacity.
7. Use the correct power pack
  - Do not use low-capacity power packs for heavy-duty work.
  - Do not use the power pack for purposes for which it is not intended.



8. Wear suitable clothing
  - Do not wear loose-fitting clothing or jewellery as these may be caught by moving parts of the power pack.
  - We recommend that anti-slip shoes are worn when working outdoors.
  - Long hair should be protected by a hair net.
9. Use protective equipment
  - Wear safety goggles or approved safety glasses whenever the work may endanger your eyes.
10. Do not use the cable for purposes for which it is not intended.
  - Do not use the cable to pull the plug out of the outlet.
  - Protect the cable against heat, oil and sharp edges.
11. Avoid abnormal body positions
  - When working stand safely and maintain your balance at all times.
12. Service your power packs with care
  - Check regularly the connecting cable of the power pack and have it replaced by an authorised specialist if damage is found.
  - Check regularly extension cables and have them replaced if they are damaged.
  - Keep handles dry, clean and free from oil and grease.
13. Pull the plug out of the power outlet
  - When not using the power pack, before performing maintenance work and when changing tools, disconnect the power pack from the power supply.
14. Use extension cables suitable for outdoor use
  - When working outdoors, use only extension cables that are approved for this type of usage and labelled accordingly.
15. Be alert
  - Pay attention to what you are doing. Work reasonably. Do not use the power pack unless you are fully concentrated.
16. Inspect the power pack for possible damage
  - Before continuing operation, all safety devices or lightly damaged parts must be inspected carefully to verify that they function properly and as intended.
  - Check if the moving parts work properly without sticking or whether parts are damaged. All parts must be fitted properly

and meet all requirements for correct operation of the power pack.

- Unless specified otherwise in the instructions for use, damaged safety devices and parts must be repaired or replaced properly by an authorised specialist workshop.
- Damaged switches must be replaced by a customer service workshop.
- Do not use any power packs on which switches cannot be turned on and off.

**Maintenance, servicing, and repairs**

Pull the power plug before adjusting any settings and prior to servicing or repairs.

Allow only an electrically skilled person to repair your power pack.

This electrical power pack conforms to all applicable safety regulations. Repairs may only be performed by an electrically skilled person using original spare parts; otherwise the user may experience accidents.

**2.6. Basic safety instructions for use of hydraulic power packs**

When operating the power pack, be sure to observe locally applicable laws and regulations.

Verify every time before using the power pack that the power pack operates in a reliable manner and is in proper condition.

The user must be familiar with the operation of the power pack. Before putting the power pack into operation, check the hose line(s) for damage. Replace any damaged hose lines, couplings and nipples without delay.

Do not couple/uncouple connected devices unless the power pack is switched off. Otherwise, the power pack may be damaged and hydraulic fluid may escape. This may result in eye injuries and burns. In case of contact with operating materials or consumables, follow the material safety data sheets and the product information relating to the operating materials.

When using an extension cord with a small cross-section and a great length, a voltage drop may occur. This will affect the start-up performance of the motor. Use only extension cables that meet the following requirements:

Mains voltage	Minimum cross-section
230/400 V	1.5 mm <sup>2</sup>
100/110 V	2.5 mm <sup>2</sup>

When working outdoors, use only extension cables that are approved for this purpose and labelled accordingly.

**2.7. Product identification**

The power pack is identified by the nameplate that is found on the cover of the control housing.

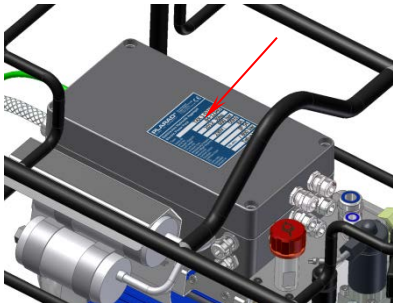

Service seal specifying the date of the next inspection



WEEE recycling/disposal instructions. This product must not be disposed of with regular household waste.

**2.8. Symbols and Warnings**



CE mark



Follow the instructions for installation and use



Wear hearing protection



Wear eye protection



Hazard warning. The hazard category is specified in the text found next to the respective warning



Warning of dangerous electrical voltage



Warning of hot surface



### 3. Product information

#### 3.1. Intended use

The PLARAD power pack is a mobile hydraulic power generator that is used to power PLARAD hydraulic torque wrenches or PLARAD tensioners for the purpose of creating bolted connections. The power pack may only be used for commercial purposes and only in connection with PLARAD tensioners.

The power pack is designed for indoor and outdoor operation at ambient temperatures of -10°C to +50°C. If intending to deviate from these conditions, consult the manufacturer first.

The power pack can be connected to a stationary factory mains network or a mobile power generator provided the power requirements specified under "Technical specifications" are observed.

Allow only Maschinenfabrik Wagner or bodies authorised by Maschinenfabrik Wagner to install, readjust, modify, upgrade and repair the power pack. Use the power pack only as described in the operating manual. Operating the power pack in a safe and reliable manner will otherwise not be possible. Unauthorised modifications may lead to unexpected hazards.

The safety of the operator and the trouble-free operation of the power pack are only guaranteed if you use original PLARAD components. This applies both to parts of the power pack and spare parts.

If different components are used, Maschinenfabrik Wagner cannot guarantee the safe and reliable operation of the power pack.

#### 3.2. Non-intended or improper use

Any use deviating from or exceeding the scope of intended use is considered to be improper. The risk lies solely with the owner / user.

#### 3.3. Other applicable operating instructions

- BGR/GUV-R 194 Use of hearing protection
- BGR 237, Rules for safe use of hydraulic hose lines
- Shell Tellus S2 V 15, PD / MSDS

### 4. Scope of delivery

Power pack, filled with oil and ready for use

#### Consumables (order more if necessary)

- Filter cartridge 10µm K20-058-4-27901
- Hydraulic oil 1 l Shell Tellus S2 V 15 K20-001-4-16402
- Hydraulic oil 5 l Shell Tellus S2 V 15 K20-001-4-16404

#### Control unit (optional accessory)

The following parts belong to the optional scope of delivery "Documentation":

- Control unit
- Docking station for control unit
- Power supply unit
- Adapter cable - power pack
- Network adapter
- Network cable
- PC software application X32
- Software - network adapter

## 5. Technical Data

Maximum operating pressure	800 bar (1,500 bar in pressure booster mode in "D1500" dual power packs)
Minimum power input for mobile power generators	4 kVA
L x W x H*	See technical data sheet
Volume flow - dual stage power packs*:	

Typ	Up to XXX bar	l/min
XB1-Z	70	5,4
	800	0,8
XB2-Z	70	8
	800	1,2
XB3,5-Z	70	13,2
	800	3

Weight*	See type plate
Mains connection	See type plate
Sound pressure level **	83.7 to 89.2 dB(A) 1m (800 bar)*

\* actual performance characteristics and dimensions/weights vary with type and model  
 \*\*when the power pack is in operation, the sound pressure level drops by 6 dB(A) with every meter of distance.

### Information about operating temperatures

When operating in temperatures of -5 °C or less, keep starting the power pack until the motor starts running (several times if necessary). Set the pressure relief valve to 400 bar. Do not connect a hose and let the power pack run for 5 minutes while holding down the black button. By doing so, you are allowing the hydraulic oil to reach its necessary operating temperature before work begins.

## 6. Transport

When using a crane or similar lifting gear for transport, attach the power pack at the attachment points identified below.

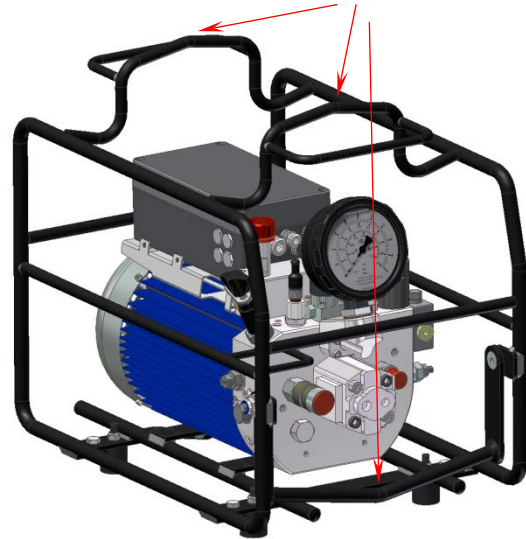

## 7. Preparing operation

This section contains a brief description of all controls and connections. The operating steps explained here are necessary for the safe use of the power pack.

### 7.1. Safety instructions for operation

	<p><b>Caution</b></p> <p>Noise emission of approx. 85 dB(A).  <b>Wear hearing protection in accordance with EN 458 if the distance between operator and power pack is less than 2 m during operation (BGR/GUV – R 194)</b></p>
	<p><b>Warning!</b></p> <p>The power pack can reach surface temperatures of up to 80°C during extended operation and in high ambient temperatures.  <b>Wear heat-resistant safety gloves! Allow the power pack to cool off before moving it.</b></p>
	<p><b>Warning!</b></p> <p>Unless set up securely, the power pack may tip over or fall down.  <b>Make sure the power pack always stands firmly on a level surface with all four feet!</b></p>
	<p><b>Warning!</b></p> <p>Hot hydraulic fluid may escape under great pressure and cause severe burns</p>

and cutting injuries.  
**Verify that the power pack is tight before putting it into service and while operation is in progress. If detecting any leaks, shut down the power pack and repair it before putting back into operation.**

### 7.2. Check the oil level of the power pack and refill oil if necessary; connect the mains voltage

1. Check the oil level. While doing so, make sure the power pack is standing horizontally to ensure a proper reading of the oil level.
2. Bring the hydraulic oil to an operation temperature of about 20°C. If necessary warm up the power pack by starting for a while. The oil level is OK if the oil level sight glass is filled according to the fixed sticker.

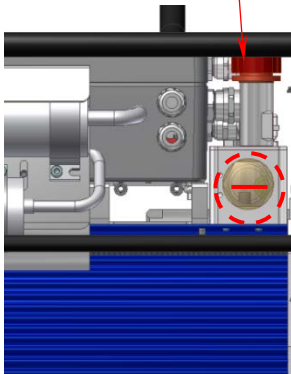

3. If the oil level is not OK, fill in hydraulic oil using the oil filler neck until the oil level sight glass is half-filled.
4. Check the mains connection lead for damage and do not connect it unless you find no damage.
5. Compare the power supply specified on the type plate with the available mains supply or the specifications of the mobile power generator. Do not connect the power plug to the power supply unless the specifications match.

The power pack starts up performing a self-test. During this test, the indicator lights on the power pack and the remote control light up for approx. 5 seconds.

While the self-test is in progress, the remote control may show error messages for a brief period of time. If these error messages are still indicated when the self-test is complete, the power pack needs to be turned in for service.

### 7.3. Select special functions with the remote control

The selection of Special Functions is by pressing and holding the red button.

The unit switches it off if necessary.

You will see a context-sensitive help screen.

This describes the function, which is triggered when (during the red button still held) is another key is pressed.

The following figure shows such a help screen examples:



Depending on the condition of the unit and the available options individual lines (functions) can be omitted in this particular case or replaced by others.

The aggregate has recognized the (further) keystroke, you can tell that the setting is highlighted in green.

example:



### 7.4. Carry out the basic settings of the power pack

Before you start operation, you can use the menu "Settings" on the remote control to carry out the basic settings for your power pack.

1. To access this menu, press and hold the red button (for at least 2 seconds) while pressing the green button at the same time.







2. Use the white and black buttons to navigate through the menu.

Use the green button to select a submenu.  
Use the red button to return to the previous menu level.

3. Select the desired language for the remote control in the submenu "Language."



4. Press the green button to store the language setting.

5. Press the red button to exit the menu.

6. Adjust the display contrast in the submenu "Contrast." To do so, select the menu item "Contrast" using the green button.



7. Adjust the contrast using the black and white buttons

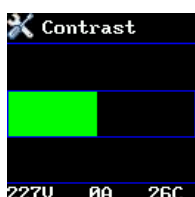

8. You can use the submenu "Information" to bring up various information about the power pack such as the serial number and the operating hours.

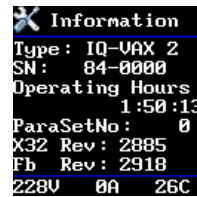

9. You can select the units in which you wish to display these values in the submenus "Temp." and "Pres." Temperature and pressure can be indicated in degrees Centigrade or degree Fahrenheit and bar or psi, respectively. Press the green button in each case to toggle the units.



### 7.5. Preparing the power pack

#### Venting

1. Connect the hydraulic hoses to the hydraulic power pack.

The pressure connection is on high-pressure side.

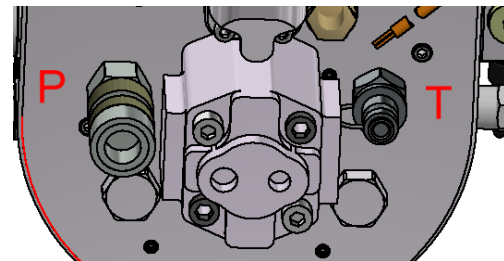

P (High pressure), T (Tank)

2. Do *not yet* connect the hydraulic torque wrench.

3. Connect the hydraulic hoses (P and T)

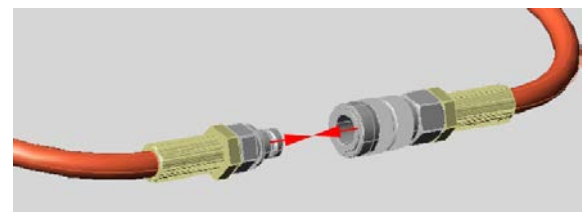

4. Press the black button to turn the power pack on. In order to clean the system, press the black button to turn the power pack on. The green LED flashes rapidly. Finish the hydraulic slucing by pressing the red button after about 3 minutes. The green LED changes from quickly to slowly flashing.

The hydraulic sluicing is without pressure from P to T. Possibly existing air inclusions will be removed from the hoses.

## 8. Working with hydraulic tools



**Attention!** When setting the hydraulic pressure, you must never exceed the maximum permissible operating pressure of the tool you are using (see torque table).

### 8.1. Choosing tensioning or loosening mode

Pressing the red button you can switch from tightening to loosening mode by also pressing the black button of the remote control simultaneously (see topic 7.3.)



- The adjusted mode will be shown by an icon in the status indicator line as well as by signal lights at the remote control.

**green LED**

Tightening mode

**red LED**

Loosening mode

This kind of tightening and loosening mode is identical in each control mode.

### 8.2. „Tightening“ mode

#### 8.1.1. Setting the desired operating pressure

- When setting the hydraulic pressure, you must never exceed the maximum permissible operating pressure of the tool you are using (see torque table).

- Press and hold the black button on the remote control and set the required hydraulic pressure at the pressure adjusting valve.

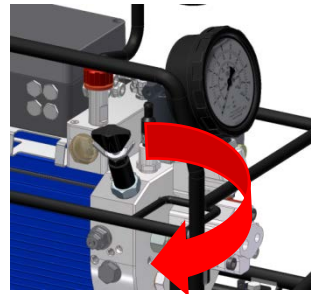

Pressure adjusting valve

- For the pressure that needs to be set, refer to the torque table of the hydraulic tool.
- The pressure is indicated at the pressure gauge of the power pack and on the display of the remote control.



Only setting of required pressure is necessary for manual screwing!

### 8.2.2. Performing the bolting operation

Connect the hydraulic torque wrench with the hydraulic lines and place it onto the bolting.

Press the black button = hydraulic tool moves forward and turns the fastener.

Release the black button = hydraulic tool moves back.

- This process is repeated until the rotation of the bolting tool is no longer visually detectable. When bolting is complete, switch off the power pack using the red button on the remote control.

### 8.3. “Loosening” mode

- When setting the hydraulic pressure, you must never exceed the maximum permissible operating pressure of the tool you are using (see torque table).

- Place the hydraulic torque wrench onto the bolt.

Press the black button = hydraulic torque wrench moves forward.

Release the black button = hydraulic torque wrench moves back.

- Repeat this process until the bolting has been loosened. When bolting is complete, switch off the power pack using the red button on the remote control.

## 9. Error messages

### Internal errors

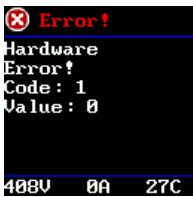

Example of an internal error message

Once connected via the power plug, the power pack will perform a self-test. The self-test starts by displaying internal error messages which will disappear once the test has been completed successfully.

While the self-test is in progress, the remote control may show error messages for a brief period of time. If these error messages are still indicated when the self-test is completed, the power pack needs to be turned in for service.

### Clear text error messages

Errors that can be corrected by the user are displayed as clear text messages:

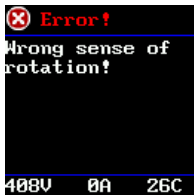

Example of user error

## 10. Remote control display

The status bar may display the following icons. The green LED will be on at the same time.



Menu



Error



Loosening mode

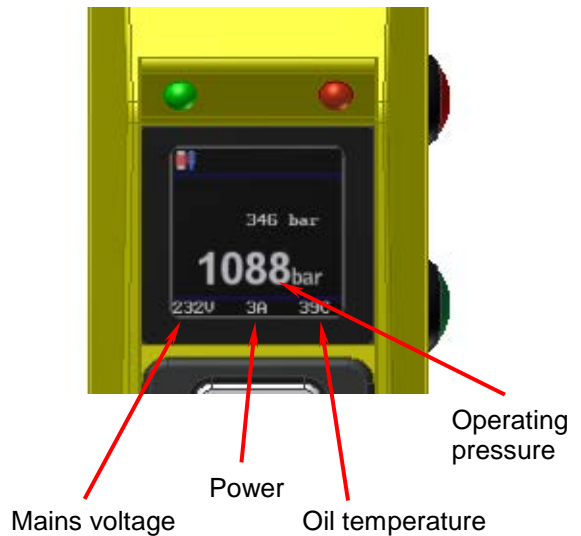

# 11. Indicator lights on the remote control

Indicator light    green    red



Blinking frequency	Function of XB/XB-Z in standard mode up to 800 bar
<b>Green indicator light is blinking slowly</b>	Bolting system is set to tightening mode. While bolting system is starting up. Calibration has not yet been performed
<b>Green indicator light is blinking rapidly</b>	Bolting system is set to tightening mode. Rapid blinking is always an indication of an ongoing process inside the bolting system, e. g. the power pack is starting up or the bolting process is in progress.
<b>Red indicator light is blinking slowly</b>	Bolting system is set to loosening mode. Calibration has not yet been performed.
<b>Red indicator light is blinking rapidly</b>	Bolting system is set to loosening mode. Rapid blinking is always an indication of an ongoing process inside the bolting system, e. g. the power pack is starting up or the loosening process is in progress.
<b>Red and green indicator light are blinking alternately</b>	An error has occurred

## 12. Maintenance instructions



**Warning!**  
 Dangerous electrical voltage.  
 Unexpected start-up as a result of inadvertent actuation.  
**Pull the power plug before adjusting any settings and prior to servicing or repairs.**

Observe the following points:

Check the oil level of the power pack on a regular basis, but at least every time before you start working.

Change the hydraulic oil every 150 hours of operation, but no later than every 12 months.

You can find the operating hours in the "Information" menu on the remote control.

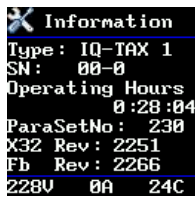

Keep the couplings and the nipples on the power pack, on the hydraulic hoses and on the tensioners clean. Use a cloth to clean the couplings and nipples before connecting them.

Seal the couplings and nipples with sealing caps prior to transport and storage.

## 13. Instructions on disposal

Dispose of the power pack as required by local regulations.



**Attention!**

This symbol points out that the product must not be disposed of with regular household waste as specified in the WEEE directive (Waste Electrical and Electronic Equipment Directive, 2002/96/EC) and national laws.

**Dispose of this product at an authorised waste collection facility. Return the product if, for instance, purchasing a similar product or take it to a waste collection facility that is authorised to recycle waste electrical and electronic equipment.**

**Turn to your local administration office, your public waste disposal authority, a facility that is authorised to dispose of waste electrical and electronic equipment or your waste management company.**



... a successful  
connection!

Maschinenfabrik Wagner GmbH & Co. KG  
Birrenbachshöhe · 53804 Much · Germany

**Tel. national:** (02245) 62-0

**Fax national:** (02245) 62-22

**Phone international:** +49 (0)2245 62-10

**Fax international:** +49 (0)2245 62-22

info@plarad.com · [www.plarad.com](http://www.plarad.com)

Reproduction and copying of this volume, in whole or in part,  
is permissible only with express written permission. Subject to  
amendment. We take no responsibility for printing  
errors or inaccurate information.

Last update: 11/2020

78766

2\_BA\_XB-Z-X32-GBR\_2.0\_78766