



# Original operating manual

## Electric nut runner: DE1eco



## Contents

Contents .....	2
1 Identification .....	3
1.1 Product identification.....	3
1.2 Document identification.....	3
2 User instructions.....	4
2.1 Purpose of the document .....	4
2.2 Target groups .....	4
2.3 Re-orders and copyright.....	5
2.4 Liability and warranty .....	5
3 Product safety .....	5
3.1 Organisational measures .....	5
3.2 Technically faultless condition.....	6
3.3 General safety information for power tools .....	6
3.3.1 Safety at the workplace .....	6
3.3.2 Electrical safety .....	7
3.3.3 Safety of persons.....	7
3.3.4 Using and handling the power tool.....	8
3.3.5 Service .....	8
4 Training of personnel.....	8
4.1 Selection and qualification of personnel .....	8
4.2 Presentation of safety instructions .....	9
4.3 Symbols on the machine.....	9
4.4 Personal protective equipment (PPE) .....	10
5 Description of the machine .....	11
5.1 Intended use .....	12
5.2 Foreseeable misuse.....	12
5.3 Design and components of the machine .....	13
5.4 Hazard areas .....	14
5.4.1 Mechanical strength .....	14
5.4.2 Temperature.....	14
5.4.3 Noise.....	14
5.4.4 Electrical energy.....	15
5.5 Technical specifications .....	16
6 Scope of delivery.....	16
7 Preparing the tool .....	17
8 Operation .....	18
8.1 Controls on the tool.....	18
8.2 Setting the torque .....	19
8.3 Operation of the tool .....	20
8.3.1 Supporting the reaction arm.....	21
8.3.2 Bolting process .....	22
8.3.3 Tightening.....	23
8.3.4 Loosening.....	23
9 Maintenance / Service.....	24
9.1 Maintenance overview .....	24
9.2 Service overview.....	25
9.3 Spare and wear parts.....	26
10 Disposal.....	26

# 1 Identification

## 1.1 Product identification

Manufacturer: Maschinenfabrik Wagner GmbH & Co. KG  
Street: Birrenbachshöhe 17  
Place: 53804 Much, Germany  
Phone: +49 (2245) 62-0  
Fax: +49 (2245) 62-66  
Email: [info@plarad.de](mailto:info@plarad.de)  
Internet: [www.plarad.de](http://www.plarad.de)

Machine designation: Electric nut runner  
Type designation: DE1eco – 36  
DE1eco – 48  
DE1eco – 80

## 1.2 Document identification

PA No.	Version	Date	Reason for change / comments
74905	1.0	04/12/2018	Initial version

## 2 User instructions

### 2.1 Purpose of the document

This operating manual is intended to familiarise the owner/operator with the machine and provide information about its possible applications and intended use. The operating manual contains important information that allows the owner/operator to use the machine safely, correctly and efficiently. Observing this information helps avoid hazards, minimise repair costs and downtimes and increase the reliability and service life of the machine.

#### Information about precautions to be taken by the owner:

- Only entrust personnel who have the necessary qualification for the respective work with tasks on the machine.
- Clearly define the responsibilities and accountabilities of the operating and maintenance personnel.
- Supplement the operating manual by rules arising from national regulations regarding occupational health and safety and the environment (e.g. work organisation).
- Order and occasionally verify compliance with the operating manual and its supplements. Keep a copy of the operating manual at the place where the machine is used at all times!
- Only operate the machine when it is in technically faultless condition and maintain this.

In addition to the operating manual, the mandatory accident prevention regulations applicable in the country and the place where the machine is used must be observed. In addition, all recognised technical rules devised to ensure safe and correct working must be observed.

### 2.2 Target groups

- a) The **owner** as the superior legal person is responsible for the intended use of the machine and the training and deployment of authorised persons. He defines the mandatory competences and authorisations of the authorised personnel for his company.
- b) A **specialist** is defined as a person who is capable of assessing the tasks assigned to him and recognising possible hazards due to his professional training, knowledge and experience. This person is also familiar with all applicable regulations. Only trained specialist personnel or such personnel who have been selected and found capable by the owner are qualified to work with the machine.
- c) A **trained/instructed person** is a person who has been instructed and, if necessary, trained in the assigned tasks and the possible risks for incorrect behaviour. This person has also been informed about the necessary safety devices and protective measures. Personnel to be qualified, trained, instructed or undergoing general job training may only act under the constant supervision of an experienced person.

## 2.3 Re-orders and copyright

Additional copies of this operating manual can be ordered at the address specified in chapter 1 "Identification". Please note that all re-orders are subject to a charge. All rights expressly reserved. Copying or disclosing the content of this operating manual to third parties - in which form whatsoever - is not permitted without our written approval.

## 2.4 Liability and warranty

All tasks and instructions provided in this operating manual are based on our previous experience and findings and given to the best of our knowledge. The original version of this operating manual was prepared in German and reviewed by us for technical accuracy. The translation into the respective national/contractual language has been prepared by a certified translation agency.

This operating manual has been compiled with the greatest level of care. However, If you discover any parts that are incomplete and/or incorrect, please notify us in writing. Your suggested improvements help us create an operating manual that is more user-friendly.

# 3 Product safety

The prerequisite for the safety-compliant handling and trouble-free operation of this machine is knowledge of the basic safety instructions.

## 3.1 Organisational measures

- a) The operating manual must always be kept in legible condition and readily available at the place where the machine is used!
- b) The operating manual needs to be supplemented by rules that incorporate the specific conditions present on site  
(e.g. duty of supervision and obligation to notify the authorities, work organisation, operational procedures, assigned personnel)
- c) The operating manual also needs to be supplemented by mandatory local regulations regarding accident prevention and environmental protection (e.g. handling hazardous materials, disposal of auxiliary and/or operating materials, and the provision/requirement to wear personal protective equipment)!
- d) Personnel must be instructed to observe the operating manual!

Personnel are required to notify the owner or his agent of any defects or hazards they have discovered.

## 3.2 Technically faultless condition

- a) All safety instructions and warnings at / on the machine must be maintained in complete and legible condition!
- b) Do not make any modifications, attachments and conversions to the machine that could impair safety without consultation/agreement with the manufacturer/supplier!

**Substantial changes to the machine and/or programs can also invalidate the EC Declaration of Conformity!**



- c) Observe all intervals for recurring checks/inspections that are required (by law) or set out in the operating manual!
- d) All spare parts used must comply with the technical requirements specified by the manufacturer. This requirement is always satisfied by the use of original spare parts.
- e) When having maintenance work performed independently, make sure to provide the appropriate workshop equipment necessary to complete the work!
- f) Apart from this operating manual, all information and instructions provided in the supplier documentations need to be observed (see appendix)!

## 3.3 General safety information for power tools

**Read all safety information and instructions. Failure to observe the safety information and instructions can result in electric shock, fire and/or serious injuries.**



The term "power tool" used throughout the safety information refers both to mains-operated power tools (with mains cable) and battery-powered electric tools (without mains cable).

### 3.3.1 Safety at the workplace

- a) Keep your work area clean and sufficiently illuminated. Working in untidy or unlit work areas can result in accidents.
- b) Do not use your power tool to work in explosive atmospheres that contain inflammable liquids, gases or dust. Power tools generate sparks that can ignite dust or vapours.
- c) Keep children and other persons away from the power tool while using it. Any distractions can cause you to lose control of your machine.

### 3.3.2 Electrical safety

- a) The connection plug of the tool must fit in the power outlet. The plug must not be modified in any way. Unchanged plugs and matching power outlets reduce the risk of electric shock.
- b) Avoid body contact with grounded surfaces such as pipes, heaters, stoves and refrigerators. There is an increased risk of sustaining electric shock when your body is grounded.
- c) Do not expose the power tool to rain, moisture and a moist environment. Water penetrating a power tool increases the risk of electric shock.
- d) Do not divert the cable from its intended use and refrain from using it to carry or hang up the power tool or pull the plug out of the power outlet. Keep the cable away from heat, oil, sharp edges or moving machine parts. Damaged or entangled cables increase the risk of electric shock.

### 3.3.3 Safety of persons

- a) When working with a power tool, stay alert, pay attention to what you are doing and apply common sense. Never operate a power tool when you are tired or under the influence of drugs, alcohol or medication. Even a brief moment of carelessness during the use of a power tool can result in serious injuries.
- b) Always wear personal protective equipment and safety goggles. Wearing personal protective equipment such as a dust mask, non-slip safety shoes, hard hat or hearing protection (depending on the type and use of the power tool) reduces the risk of injury.
- c) Avoid any inadvertent start-up of the machine. Ensure that the power tool is switched off before connecting it to the power supply before picking it up or carrying it. Carrying the power tool with your finger on the switch or connecting it to the power supply while the device is switched on can result in accidents.
- d) Remove all adjusting tools or spanners before switching on the power tool. Any tool or spanner located in a rotating machine part can result in injuries.
- e) Refrain from assuming an abnormal body posture. Assume a firm stand and keep your balance at all times. This will help you retain better control over the power tool if faced with unexpected situations.
- f) Wear suitable clothing. Do not wear any loose-fitting clothes or jewellery. Keep hair, clothing and gloves out of reach of moving parts. Loose-fitting clothes, jewellery or long hair may become caught in moving components.

### 3.3.4 Using and handling the power tool

- a) Do not overload the machine. Use the power tool that is designed for the work you wish to complete. Using the appropriate power tool will help you work more efficiently and safely within the specified range of capacity.
- b) Do not use any power tools that have a defective switch. A power tool that can no longer be switched on or off is dangerous and must be repaired.
- c) Remove the plug from the power outlet and/or remove the battery before making any adjustments to the machine, changing accessories or putting the machine away. This precaution prevents unintended start of the power tool.
- d) Store power tools that are not in use out of reach of children. Never allow persons to use the machine who are not familiar with its operation or who have not read the instructions. Power tools are dangerous if used by inexperienced persons.

### 3.3.5 Service

- a) Only let your power tool be repaired by qualified specialist personnel and only with original spare parts. This ensures that the safety of the power tool is maintained.
- b) Maintain the power tool with care. Check if moving parts function properly and without sticking and whether parts are broken or damaged so that the power tool's function is impaired. Have damaged parts repaired before using the machine. Many accidents can be attributed to poorly maintained power tools.
- c) Use power tools, accessories, insertion tools, etc. in accordance with these instructions. During use, take into consideration the operating conditions and the task to be completed. The use of power tools for applications other than the ones specified can result in dangerous situations.

## 4 Training of personnel



### 4.1 Selection and qualification of personnel

- a) Only reliable personnel are permitted to work on/with the machine. Observe the minimum age requirements stipulated by law!
- b) Only use trained or at least instructed personnel! Instruct and occasionally verify that only authorised personnel are used to work on/with the machine!
- c) Clearly define the responsibilities and accountabilities of the personnel with regard to operation, set-up, maintenance and repair!
- d) Only let personnel undergoing training, instruction or in the context of general training work on the machine while under constant supervision by an experienced person!
- e) Work on electrical equipment of the machine must only be performed by qualified electricians or instructed persons under the management and supervision of a qualified electrician. The electrical engineering regulations must be complied with for safety reasons.









## 4.2 Presentation of safety instructions





The operating manual uses the following illustrations to depict safety instructions:

<b>Danger:</b> Specifications / instructions and warnings intended to prevent personal injury	 Danger
<b>Attention:</b> Particular specifications / instructions and warnings intended to prevent property damage	 Attention
<b>Notice:</b> Particular specifications / instructions and warnings regarding the proper and efficient use of the machine	

## 4.3 Symbols on the machine

Warning about dangerous electrical voltage	
Crushing hazard warning	
Warning about hot surface	
Read all safety information and instructions. Failure to observe the safety information and instructions can result in electric shock, fire and/or serious injuries.	
Class 2 protective insulation	
This symbol indicates that the product must not be disposed of with regular household waste as specified in the WEEE directive (Waste Electrical and Electronic Equipment Directive, 2002/97/EC) and national laws.	
Service seal specifying the date of the next inspection.	

#### 4.4 Personal protective equipment (PPE)

Use gloves	
Use protective footwear	
Wear hearing protection	
Wear protective headgear	
Use protective eye wear	

## 5 Description of the machine

Illustration and identification

The electric nut runner is identified by its type plate.

The position of the type plate is found in the illustration below:

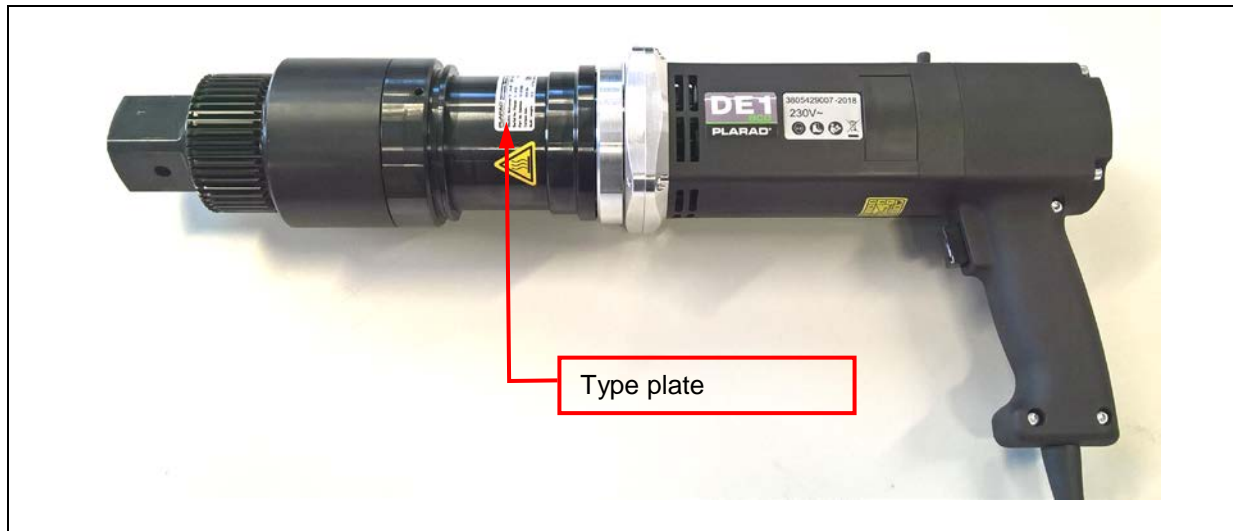

The following specifications are given on the type plate:

- Company name including complete address
- Machine designation:
- Type designation:
- Item or Serial no.:
- Maximum torque:
- Year of manufacture:
- Weight:
- Mains voltage / frequency:
- CE mark

**Note the mains voltage and frequency stated on the rating plate!**



**Attention**

## 5.1 Intended use

Within the limits of supply, the machine has been manufactured in accordance with the state of the art and the recognised technical safety rules. Regardless, the use of the machine involves certain risks to the life and limb of the user or third parties as well as the risk of damage to the machine and other material assets.

The machine may only be used if in proper technical condition, in accordance with its intended use, with an awareness of safety and the risks involved and in observance of the operating manual!

It is of particular importance in this regard to have any faults that may affect safety eliminated without delay!

The electric nut runner is a hand-held tool that is designed exclusively for tightening and loosening bolted connections (see ch. 5.1).

It may only be used for commercial purposes.

Any use deviating from or exceeding the scope of intended use is considered to be improper.

The manufacturer/supplier **cannot** be held liable for any damage resulting from such improper use.

The risk lies solely with the owner.

**Intended use also includes observing the operating manual and the conditions specified for inspections and maintenance.**



## 5.2 Foreseeable misuse

- The electric nut runner is not suitable for continuous operation as a drive unit.
- Do not subject bolting systems and accessories to more than the permissible torque. Ch. 8
- The tool must not be used to tighten pretensioned bolts. Ch. 8.3
- Impermissible support scenario. Ch.8.3
- Lower deviation from starting rotation angle. Ch.8.3
- Observe the protection rating. Ch.5.5
- The assignment of torque level and torque has been determined on a test set-up according to ISO 5393 (medium hard test set-up). Other torque levels can be necessary depending on the bolting application. Ch. 8.2

### 5.3 Design and components of the machine

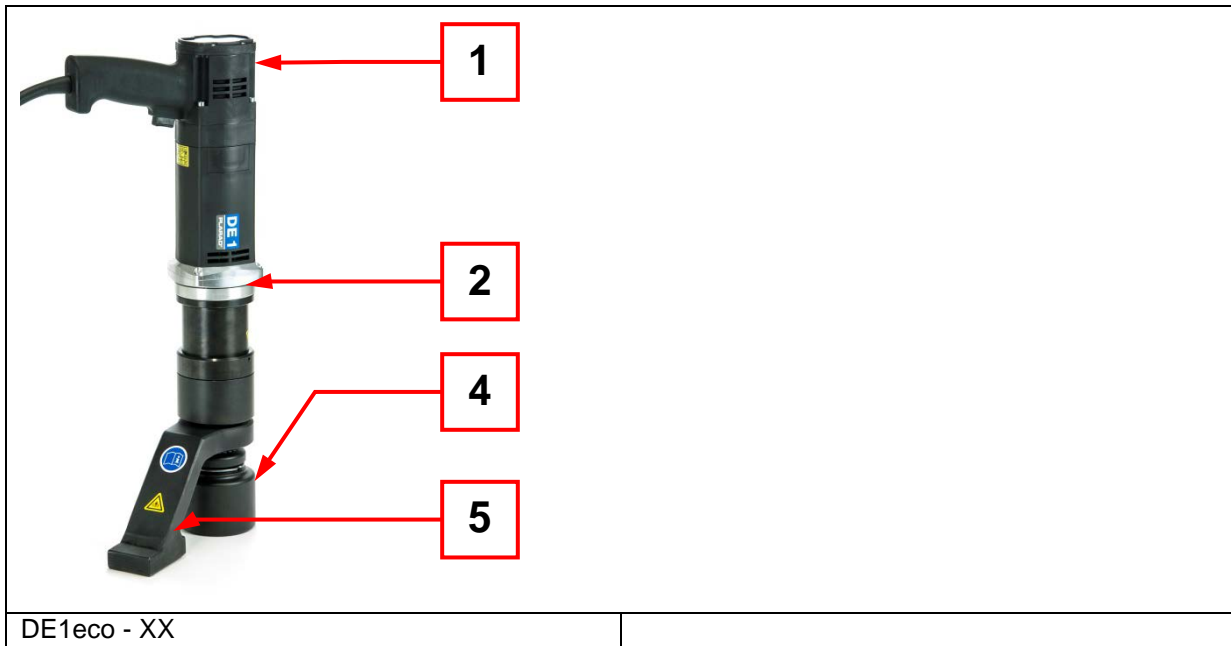

#### Tool components:

1. Drive motor
2. Safety pivot

The safety pivot situated between drive motor and gearbox/angular gearbox makes it possible to rotate the grab handle into any desired position - even under load.

The total reaction force of the nut runner will not affect your hand during this process.

**Shearing of the mains power cable! Contact with live components can result in serious injuries and death from electric shock.**

**The mains power cable must never be situated between reaction arm and contact surface while you are working with the tool.**

**Only use the insulated handles to guide the tool during work.**



**Danger**

#### Accessories:

3. Impact socket with retaining clip
4. Reaction arm

**When setting the torque, strictly ensure that the maximum permissible torque of the tool and the accessories is not exceeded.**



**Danger**

**There is a crushing hazard between the reaction arm and the contact surface. The reaction arm attached to the tool can cause serious crushing injuries. Do not reach between the reaction arm and the contact surface. Do not place hands/feet close to the contact surface.**



**Danger**



**Only components and accessories that do not impair the function and safety of the tool are permitted to be used.**



**Danger**

## 5.4 Hazard areas

### 5.4.1 Mechanical strength

<p>Only components and accessories that do not impair the function and safety of the tool are permitted to be used. Only use impact sockets</p>	 Attention
<p>Unsecured components or tools can be flung out! Secure reaction arm and impact socket before start-up! Follow the instructions and warnings provided on the tool and the accessories.</p>	 Danger
<p>When setting the torque, strictly ensure that the maximum permissible torque of the accessories is not exceeded.</p>	 Danger

### 5.4.2 Temperature

<p>Risk of burns! When used in high ambient temperatures, the tool can reach surface temperatures of up to 80°C. Wear protective gloves.</p>	 Danger
--	--

### 5.4.3 Noise

<p>Hearing damage from noise! Wear hearing protection during operation.</p>	 Danger
---	---

## 5.4.4 Electrical energy

**Contact with live components can result in serious injuries and death from electric shock.**



**Danger**

Observe the following safety information when operating electric nut runners:

- a) When operating the tool, observe all applicable laws and regulations at the operating site.
- b) Verify every time before using the tool that it operates in a reliable manner and is in proper condition.
- c) Before putting the tool into operation, check the tool and the mains power cable for damage.
- d) Never continue using a defective tool or a tool with defective cables or connectors.
- e) Have damaged cables or connectors replaced by authorised qualified electricians before resuming operation.
- f) When using an extension cable with small cross section and large length, a voltage drop can occur which adversely affects the start-up and function of the nut runner.
- g) When working outdoors, only use extension cables that are approved for this purpose and labelled accordingly.
- h) Do not expose electric tools to rain. Do not use power tools in a moist or wet environment.
- i) Keep your tools in a safe place. Store unused power tools in a dry room.
- j) Disconnect the tool from the mains power supply before all repair and maintenance work.



**Minimum cross section of supply lines min 2.5mm<sup>2</sup>  
Fully unwind cable drums!**



**Attention**

## 5.5 Technical specifications

<b>Dimensions:</b>	see technical data sheet
<b>Weight:</b>	see type plate
<b>Range of capacity:</b>	see included torque table
<b>Mains voltage:</b>	230 V/50 Hz
<b>Power consumption:</b>	1.4 kW
<b>Insulation class:</b>	E
<b>Protective insulation:</b>	Protection rating IP 20
<b>Minimum power input for mobile power generators:</b>	4 kVA
<b>Ambient temperature:</b>	0°C ≤ T ≤ 50°C
<b>Emission values according to EN 60745:</b>	
<b>Sound pressure level:</b>	79dB(A), uncertainty factor: 3 dB(A)
<b>Vibration emission value:</b>	< 2.5 m/s <sup>2</sup> , uncertainty factor: 1.5 m/s <sup>2</sup>

<b>Allow the tool to warm up in temperatures below 0°C!</b>	 <b>Attention</b>
<b>The technical specifications of accessories and the safety data sheets must be observed as well!</b>	 <b>Attention</b>

## 6 Scope of delivery

- Electric nut runner, ready for operation
- Reaction arm
- Optional impact socket
- Circlip pliers for installing the retaining ring on the reaction arm
- Operating manual including EC Declaration of Conformity
- Torque table with (optional) test certificate
- Case



## 7 Preparing the tool

Only components and accessories that do not impair the function and safety of the tool are permitted to be used.  
Only use impact sockets



1. Attach O-ring to tothing



2. Attach the reaction arm to the toothed holder on the nut runner.
3. Secure the reaction arm using the retaining ring / circlip pliers.
4. Put the socket insert (socket) on the square drive on the nut runner and secure it. Only use impact sockets.
5. Secure the impact socket.



6. Nut runner with secured reaction arm and secured impact socket.



Unsecured components or tools can be flung out!  
Secure reaction arm and impact socket before start-up!  
Follow the instructions and warnings provided on the tool and the accessories.







## 8 Operation

### 8.1 Controls on the tool



1. Display / buttons
2. Power button
3. Rotation direction lever





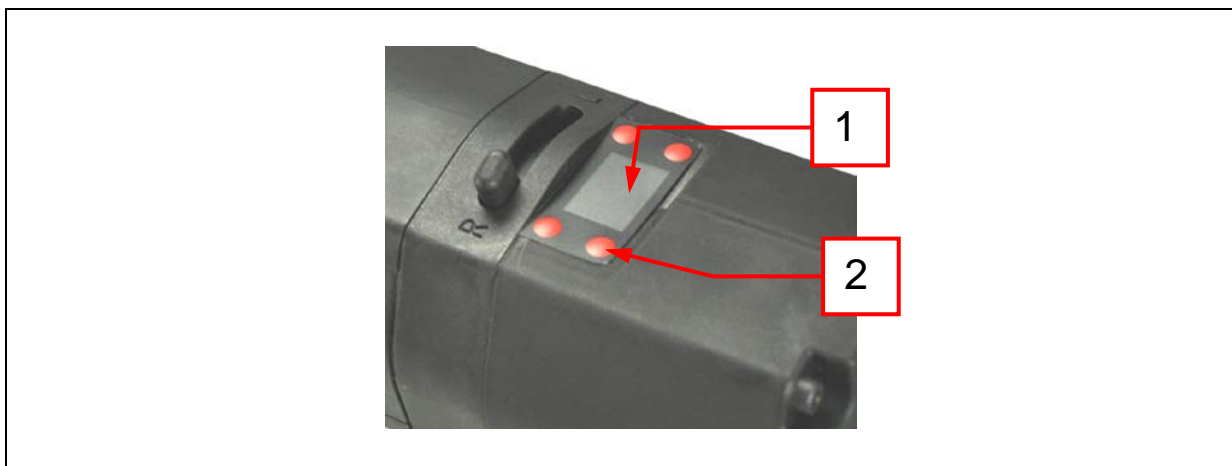



## 8.2 Setting the torque

<p>When setting the torque, strictly ensure that the maximum permissible torque of the accessories is not exceeded.</p>	 Danger
<p>You need to set the desired torque (torque angle) before starting the bolting process! Making adjustments while the bolting process is underway is not possible!</p>	 Attention
<p>The indicated torque has been determined on a dynamometer and corresponds to a medium hard test set-up according to ISO5393. Other torque levels can be necessary depending on the bolting application! For accuracy, see ch.5.5 Technical specifications.</p>	 Attention
<p>The torque is selected by adjustment of the corresponding torque level. Refer to the included torque table for the required torque level.</p>	
<p><b>Notice:</b> Particular specifications / instructions and warnings regarding the proper and efficient use of the machine</p>	





1. Set the desired torque on the display (1) found above the grab handle.  
Refer to the included torque table for the necessary set value.
2. Press the buttons (2) next to the display to set the torque level.  
Press the upper and the lower button to, respectively, increase or reduce the value of the currently displayed digit.

### 8.3 Operation of the tool

<p>Do not work in a way that may endanger safety! Tie back long hair and refrain from wearing loose clothing or jewellery (there is a risk of injury from becoming entangled or drawn in)!</p>	 <b>Danger</b>
<p>Do not use the machine unless it operates in a reliable manner and is in proper condition!</p>	 <b>Danger</b>
<p>Before switching the machine on, make sure that no one is put at risk by the machine starting up!</p>	 <b>Danger</b>
<p>Only use reaction arms or extensions that have been approved by the manufacturer.</p>	 <b>Danger</b>
<p>Check the machine for visible external damage and defects at least once per shift! Report any detected changes (including changes in performance) to the supervising staff without delay! If necessary, shut down and secure the machine immediately!</p>	 <b>Attention</b>
<p>Modifications to the reaction arm can invalidate the included original performance table.</p>	 <b>Attention</b>
<p>Operate the tool as specified in the operating manual; follow control indicators!</p>	
<p>Suitable reaction arms - including custom models - are available on request. Reaction arms must never be modified.</p>	

### 8.3.1 Supporting the reaction arm

Torques cannot be generated without an absorption of the reaction forces. This function is provided by the nut runner's reaction arm. A standard reaction arm is included in the scope of delivery of the tool. The tool is only permitted to be used with the included reaction arm.

<p><b>If the reaction arm rests only partially against the surface at the corners of the reaction foot, considerable forces can impact the tool. The device accessories can break, and the tool may be flung out. Do not support tool on the corners of the support feet!</b></p> <p><b>Only support tool on the surfaces of the support feet!</b></p>	 <b>Danger</b>
<p><b>Make sure the supporting plate rests fully against the surface!</b></p>	 <b>Attention</b>



<p><b>If supported insufficiently, the tool can slip off and be flung out. The thrust bearing at the bolting position must prevent the reaction arm from slipping off the contact surface!</b></p> <p>See also ch. 5.3 Design and components of the machine</p>	 <b>Danger</b>
---	--

### 8.3.2 Bolting process

- a) Place the nut runner on top of the bolting so that the bolt head/nut is captured in its entirety by the socket or the hexagon socket insert. If this is not possible, you may only subject the accessories to reduced torque or use a special socket/different accessories.
- b) Bring the nut runner with the supporting plate into contact with the thrust bearing against the desired rotational direction of the nut runner. Make sure it rests against the entire surface!

The tool can exceed the specified torque if the starting rotation angle (reaction arm + bolt) is too small.

The following values are recommended for the starting rotation angle:

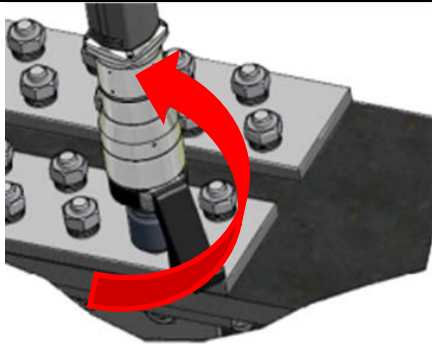

DE1 **eco**:

- -36 30°
- -48 30°
- -80 30°



**Danger**

Components or the bolted connections may tear during work. The tool can be flung out of the bolting position.





**Danger**

### 8.3.3 Tightening





- a) Connect the tool to the mains power supply.
- b) Preselect the rotation direction on the hand lever.
- c) Place the nut runner with the socket wrench insert on top of the bolt head or the nut you wish to turn.
- d) Support foot against the desired rotation direction of the tool.
- e) Press down and hold the power button until the nut runner switches off.
- f) Check the torque using suitable means if necessary.

### 8.3.4 Loosening

<p><b>Loosening boltings often requires higher levels of torque than are necessary for tightening boltings.</b></p> <p><b>When faced with a situation like this, you will find that standard sockets and accessories often do not provide the necessary stability.</b></p> <p><b>Also, the power of the tool is usually greater than the load capacity of the accessories.</b></p>	 <b>Attention</b>
<p><b>Note that the accessories are only permitted to be loaded with the maximum permissible torque.</b></p>	 <b>Danger</b>

- a) Preselect the rotation direction on the hand lever. Attach the reaction arm to the thrust bearing against the desired rotation direction of the nut runner.
- b) Press down and hold the power button until the bolt or the nut has been loosened. Do not press the power button more than once!

## 9 Maintenance / Service

Performing regular maintenance and inspections on the machine is of great importance. This minimises the occurrence of faults and increases operational reliability.	
Auxiliary and operating materials as well as cleaning agents and replacement parts need to be disposed of in a safe and environmentally compliant manner! Follow the instructions of the manufacturer when dealing with hazardous materials!	
Work on the technical equipment of the machine (electrical system) may only be performed by qualified experts!	 Danger
Service work may only be performed by the manufacturer. Only allow Maschinenfabrik Wagner or bodies authorised by Maschinenfabrik Wagner to install, readjust, modify, expand and repair the tool.	 Attention

### 9.1 Maintenance overview

The tool must be serviced as specified in the maintenance schedule before and after use.

Maintenance schedule				
Component / check	Type of check	Process	Interval	Comment
Surfaces Warnings and pictograms	Visual inspection	Check/clean	Before/after use	
Check the power cable for: <ul style="list-style-type: none"> <li>• Proper fastening</li> <li>• Damage</li> </ul>	Visual inspection	Check	Before/after use	
Check the impact socket for: <ul style="list-style-type: none"> <li>• Damage</li> <li>• Operation of the retaining clip</li> </ul>	Visual inspection	Check	Before/after use	
Check the reaction arm for: <ul style="list-style-type: none"> <li>• Damage</li> <li>• Operation of the retaining ring</li> </ul>	Visual inspection	Check	Before/after use	



## 9.2 Service overview

**Service work may only be performed by the manufacturer. Only allow Maschinenfabrik Wagner or bodies authorised by Maschinenfabrik Wagner to install, readjust, modify, expand and repair the tool.**



**Attention**

Throughout the useful life of the machine, it is necessary to perform a variety of service operations. The service intervals need to be shortened if the machine is used in particularly harsh and demanding work environments.

The following service intervals must be observed depending on the conditions of use (see also ch.9.1 Maintenance overview):

### Every 3 months:

- In extreme usage conditions
- If application frequency is high / multi-shift operation
- If used continuously for work in the upper torque range (level 66 - 99)
- if used for soft bolting applications

### Every 6 months:

- In normal usage conditions
- If application frequency is medium
- If used for work in the medium torque range (level 33 - 65)

### Every 12 months:

#### If application frequency is low

- If used for work in the low torque range (level 00 - 32)

Service schedule			
Component / service	Type of check	Process	Comment
Tool	Visual inspection	Damage Pictograms avail.	
Electric. Drive	Service drive	Check Software update	
Gearbox	Service gearbox	Check Service lubrication	
Tool	Check of electrical system	Check according to DGVU regulation 3	
Tool	Recalibration	Calculation of the characteristic curve	Preparation of the torque table / factory certificate
Accessories	Visual inspection / function check	Damage Pictograms avail. Check	

### 9.3 Spare and wear parts





All spare parts used must correspond to the technical requirements stipulated by us. This requirement is satisfied by the use of original spare parts. We only grant a warranty on the original spare parts we supply. The installation and/or use of spare parts not supplied by us may have a negative impact on the specified design properties, thereby impairing active and/or passive safety. We do not assume any liability and warranty for any damage that can be attributed to the use of spare parts / accessories other than those supplied by us.

We require the following information to process your order in an efficient and expedient manner:

1. Client
2. Serial number of the device
3. Designation of the desired spare part
4. Desired units
5. Desired shipping method

Refer to chapter 1 "Identification" for our address

## 10 Disposal

<p><b>All materials used need to be disposed of in a safe and environmentally compatible way. Observe all applicable national regulations!</b></p>	 <b>Attention</b>
<p><b>The device must not be disposed of with regular household waste as specified in the WEEE directive (Waste Electrical and Electronic Equipment Directive, 2002/97/EC) and national laws.</b></p>	 <b>Attention</b>
<p><b>Dispose of this product at an authorised waste collection facility. Return the product if, for instance, purchasing a similar product or take it to a waste collection facility that is authorised to recycle waste electrical and electronic equipment.</b></p>	 <b>Attention</b>
<p><b>Turn to your local administration office, your public waste disposal authority, a facility that is authorised to dispose of waste electrical and electronic equipment or your waste management company.</b></p>	 <b>Attention</b>